

Technical data sheet

Counter-trough, metal, universal A2

Item number: 1197096



Metal counter-trough, for mounting on clamp clip. Can be used universally, irrespective of the rail.



A2 Stainless steel

2B Bright, treated

Master data

Item number	1197096
Type	2058FW M 8 A2
Description 1	Counter-trough
Manufacturer	OBO
Dimension	4-8mm
Material	Stainless steel
Surface	Bright, treated
Surface standard	
Smallest sales unit	100
Unit of quantity	Piece
Weight	0.249 kg
Weight unit	kg/100 pc.

Technical data sheet

Counter-trough, metal, universal A2

Item number: 1197096



Dimensions



Dimension B	13 mm
Dimension H	2.25 mm
Dimension L	35 mm

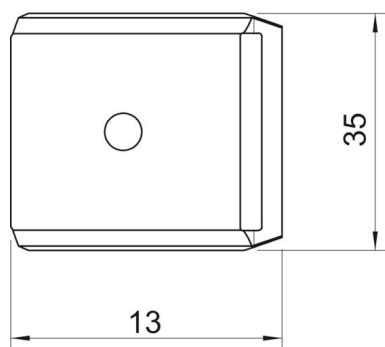

Technical data

Counter-trough/clip version	Counter sleeve
Suitable for max. cable diameter	8 mm
Halogen-free	yes
Clamping range D, max.	8 mm
Clamping range D, min.	4 mm