

# Technical data sheet

## Fastening panels

Item number: 6288005



Fastening panel for mounting device installation trunking on skirting board constructions and as a support for the convection grid. The fastening panel can be used for all Rapid 80 device installation trunking systems of type GK and GA. When mounting plastic GK device installation trunking, the matching wall panel adapter is also required. The connection profile is required for mounting double trunking of type GS-D70170 and GS-D90170, as well as for GS trunking with a nominal width of 210 mm.

The mesh slats are simply attached to the slat holder.



**St** Steel

**FS** Strip galvanized

### Master data

Item number	6288005
Description 1	Fixing panel
Description 2	depth 120-205
Manufacturer	OBO
Dimension	140x128x205
Material	Steel
Surface	Strip galvanized
Surface standard	DIN EN 10346
Smallest sales unit	1
Unit of quantity	Piece
Weight	68 kg
Weight unit	kg/100 pc.

# Technical data sheet

## Fastening panels

Item number: 6288005



### Dimensions

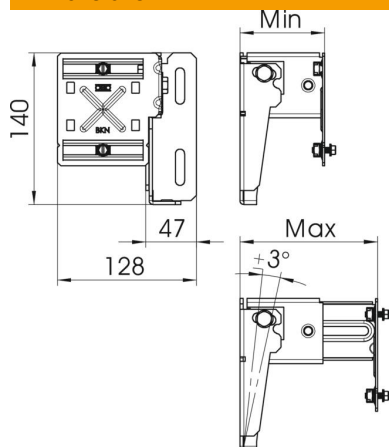

Length	205 mm
Width	128 mm
Height	140 mm

### Technical data

Version for	120–205 mm
Version for	Wall mounting
Fastening type	Screw-on
Trunking mounting	Screw
Spacing from wall, max.	205 mm
Spacing from wall, min.	120 mm