

# Technical data sheet

Cover for 90° bend FS

Item number: 6225994



Cover with turn buckles for covering 90° cable ladder bends with welded rungs.

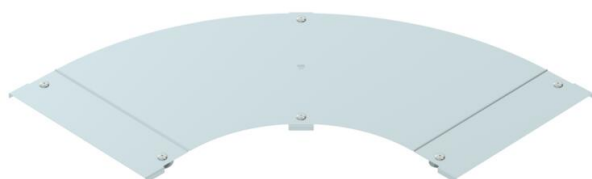

**St** Steel

**FS** Strip galvanized

## Master data

Item number	6225994
Type	LBD 90 400 R3 FS
Description 1	90° bend cover
Description 2	with turn buckle
Manufacturer	OBO
Dimension	B400
Material	Steel
Surface	Strip galvanized
Surface standard	DIN EN 10346
Smallest sales unit	1
Unit of quantity	Piece
Weight	331 kg
Weight unit	kg/100 pc.

# Technical data sheet

## Cover for 90° bend FS

Item number: 6225994



### Dimensions

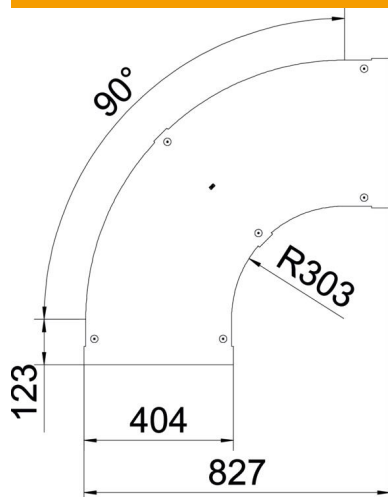

Width	400 mm
Plate thickness	1 mm
Dimension B	400 mm

### Technical data

Bend (angle)	90°
Fastening type	Sash lock
Maintain electrical functions	no
Suitable for mesh cable tray	no
Suitable for cable ladder	yes
Suitable for cable tray	no
Change of direction	Horizontal
Rustproof steel, pickled	no
Hinged	no