

Technical data sheet

Adjustable bend element 60 A2

Item number: 6225462



Adjustable bend element with welded rung for use in cable ladder types with a side height of 60 mm.



A2 Stainless steel

2B Bright, treated

Master data

Item number	6225462
Type	LGBE 630 A2
Description 1	Adjustable bend element
Description 2	for cable ladder
Manufacturer	OBO
Dimension	60x300
Material	Stainless steel
Surface	Bright, treated
Surface standard	
Smallest sales unit	1
Unit of quantity	Piece
Weight	97 kg
Weight unit	kg/100 pc.

Technical data sheet

Adjustable bend element 60 A2

Item number: 6225462



Dimensions

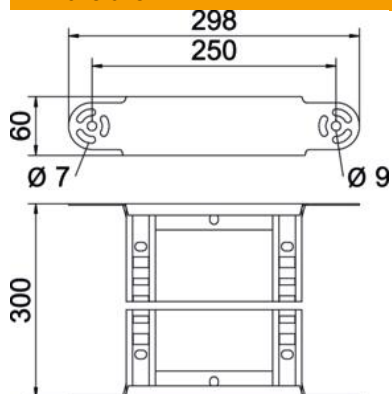

Width	300 mm
Height	60 mm
Dimension B	300 mm
Dimension R	300 mm

Technical data

Bend (angle)	Adjustable
Version of the rungs	Profile perforated
Side rail version	Flat profile
Connector version	Integrated connector
Maintain electrical functions	no
Change of direction	Vertical, rising/falling
Rustproof steel, pickled	no
Hinged	no
Side perforation	no
Wide-span version	no
Rail thickness	1.5 mm