

Technical data sheet

Adjustable bend element, vertical 85 FS

Item number: 7005466



Adjustable vertical bend element, for all cable tray types with a side height of 85 mm.
RGV 85 adjustable connectors should be ordered separately and in the appropriate quantity.



St Steel

FS Strip galvanized

Master data

Item number	7005466
Type	RGBEV 810 FS
Description 1	Adjustable bend element
Description 2	vertical
Manufacturer	OBO
Dimension	85x100
Material	Steel
Surface	Strip galvanized
Surface standard	DIN EN 10346
Smallest sales unit	1
Unit of quantity	Piece
Weight	71.5 kg
Weight unit	kg/100 pc.

Technical data sheet

Adjustable bend element, vertical 85 FS

Item number: 7005466



Dimensions

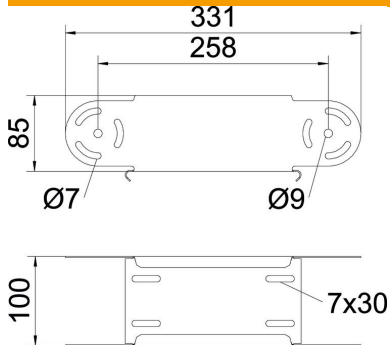

Width	100 mm
Width	4 in
Height	85 mm
Height	3 in
Plate thickness	1 mm
Dimension B	100 mm

Technical data

Bend (angle)	Adjustable
Connector version	Without connectors
Type	Adjustable bend element
Maintain electrical functions	no
Mounting perforation in base	no
NATO hole pattern	no
Change of direction	Vertical, rising/falling
Rustproof steel, pickled	no
Side perforation	no
Wide-span version	no
Type of connector, cable support system	Screwed