

Technical data sheet

TP support FS

Item number: 6364322



TP support for fastening to horizontal concrete ceilings.
If the profile is fastened directly to the ceiling or the profile is screwed together as head reinforcement, then, for reasons of stability, always use the spacer, type DS 4.

Important: only use brackets of length 345 mm or less.



St Steel

FS Strip galvanized

Master data

Item number	6364322
Description 1	TP suspended support
Manufacturer	OBO
Dimension	L445mm
Material	Steel
Surface	Strip galvanized
Surface standard	DIN EN 10346
Smallest sales unit	1
Unit of quantity	Piece
Weight	73 kg
Weight unit	kg/100 pc.

Technical data sheet

TP support FS

Item number: 6364322



Dimensions

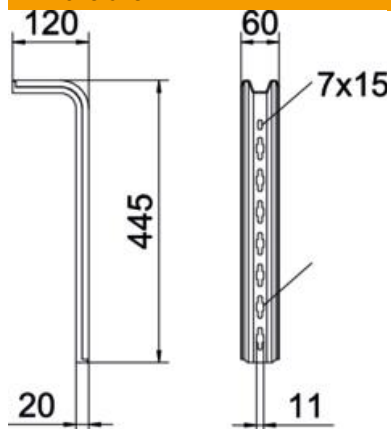

Length	445 mm
Width	60 mm
Height	120 mm
Dimension H	120 mm
Dimension L	445 mm

Technical data

Version for	S profile
Maintain electrical functions	no

Loads

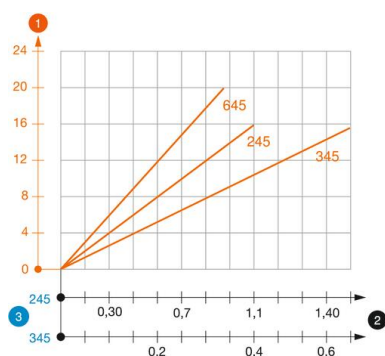

Load diagram, TP support, type TPS

- 1 Bending of the end of the suspended support at permitted bracket load
- 2 Permitted bracket load in kN without man load
- 3 Bracket length in mm
- Load curves with support lengths in mm

Characteristic anchor load values for TP support

Single-sided load

Anchor type	Max. load [kN]		
	Bracket width [mm]		
	145	245	345
BZ3 8x75/0-20	1.48	0.93	0.68
BZ3 10x90/0-30	1.48	0.93	0.68

Max. total load $F = \text{cable weight} + \text{cable tray} + \text{bracket} + \text{suspended support}$. The tabular values for double-sided loads take the available axis spacing $a_i = 17 \text{ cm}$ into account. The load capacity values increase considerably when used in uncracked concrete. The specified values are based on concrete of resistance class C20/25. Comply with the installation conditions of the DIBt approval (anchors).