

Technical data sheet

Cable gland, metric thread with multi-way seal insert, light grey

Item number: 2022110



Cable gland with metric connection thread in cap nut design, suitable for junction boxes, housings, distributor cabinets in private and industrial areas. With strain relief and integrated sealing lip, tested according to DIN EN 62444. Protection class IP68. Can be used between -20°C and $+65^{\circ}\text{C}$.



PA Polyamide

Master data

Item number	2022110
Type	V-TEC VM20 2x4
Description 1	Cable gland
Description 2	with multi-way seal insert
Manufacturer	OBO
Dimension	M20
Colour	Light grey
Material	Polyamide
Smallest sales unit	50
Unit of quantity	Piece
Weight	0.86 kg
Weight unit	kg/100 pc.

Technical data sheet

Cable gland, metric thread with multi-way seal insert, light grey

Item number: 2022110



Dimensions

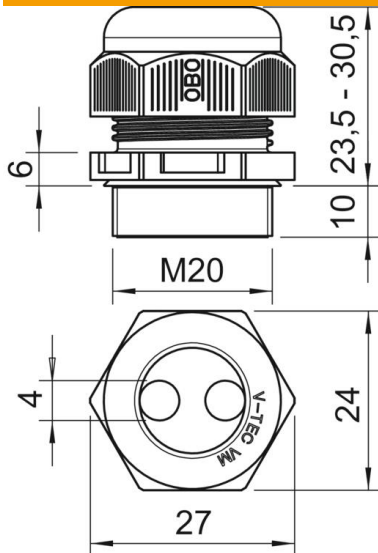

Dimension D	4 mm
Dimension E	27 mm
Dimension L max.	30.5 mm
Dimension L min.	23.5 mm
Dimension L1	10 mm
Dimension L2	6 mm

Technical data

Number of drill holes	2
Type of seal	Sealing ring
Version for	Straight
Bend protection	no
explosion-proof	no
Flat cable gland	no
Flame-resistant	acc. to VDE 0471/DIN 695 Part 2-1, test temperature 650°C
For Ex zone	Without
For Ex zone gas	Without
For Ex zone dust	Without
Thread	M20 x 1,5
Thread type	Metric
Thread length	10 mm
Nominal thread size	20
Thread increase	1.5 mm
Fibre-glass reinforced	no
Halogen-free	yes
Unstable torque	3.8 Nm
Sealing insert, multiple	no
With locknut	no
Impact-resistant	no
WAF	24
Protection rating	IP68
Hexagonal corner dimension	27 mm
Splittable gland	no
Permitted temperature range, max.	65 °C
Permitted temperature range, min.	-20 °C

Technical data sheet

Cable gland, metric thread with multi-way seal insert, light grey

Item number: 2022110



Technical data

Strain relief option	yes
----------------------	-----